

### Parts

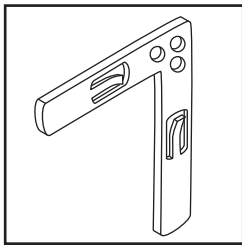

(8) Corner Brackets

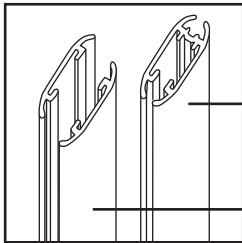

(3) Solid Ano Rails

(2) Split Ano Rails

### Steps

#### Frame Assembly

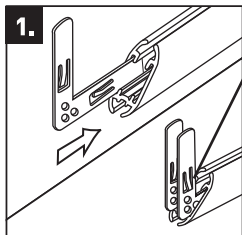

1. Identify split rails and solid rails. Solid rails are the same length as the split rails. Insert corner brackets into ends of these rails.

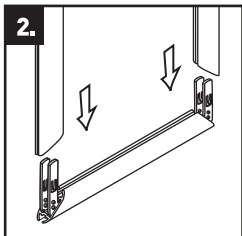

2. Push remaining solid rails onto solid rail with brackets from step 1.

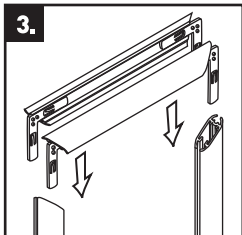

3. Push split rails onto frame.

Note: Please layout parts in order on the floor before assembly.

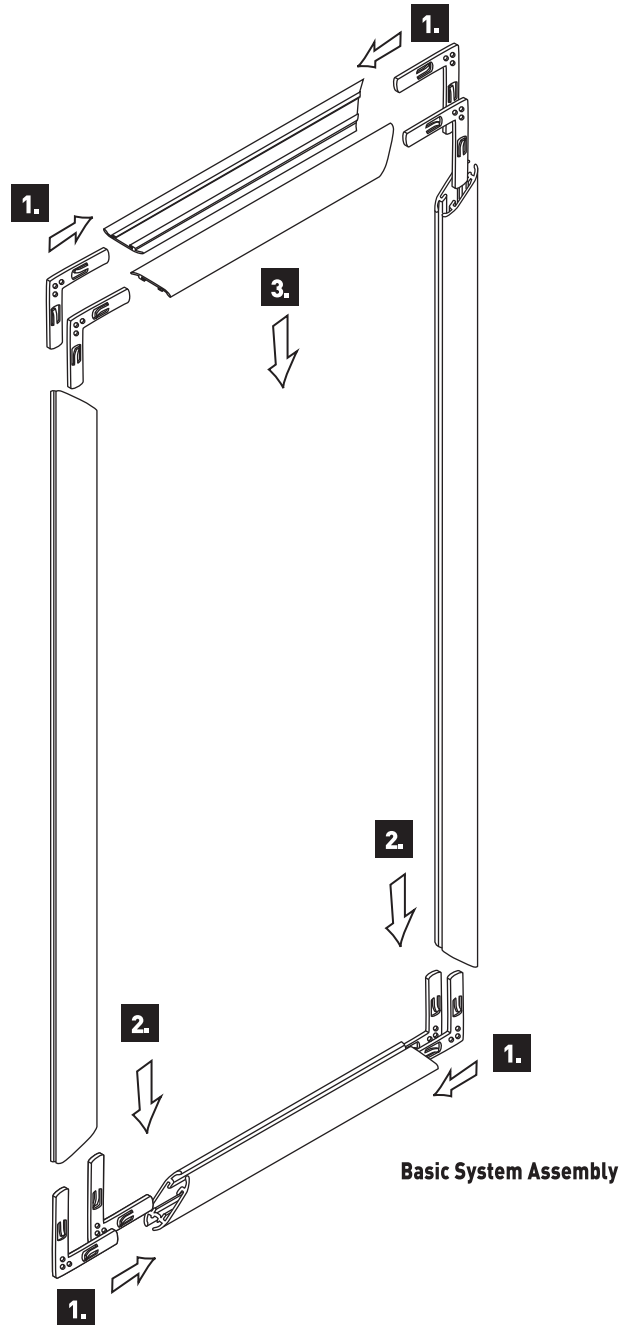

# Installation Guidelines

## Parts

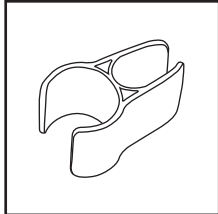

SnapOn Clip™

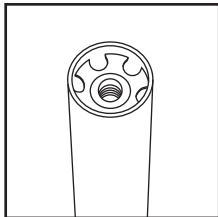

Pole

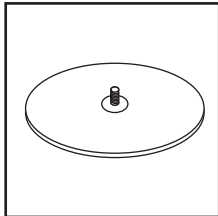

Pole Base

## Steps

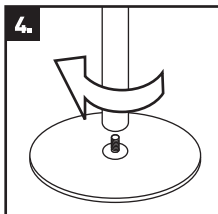

4. Screw poles onto bases. Tighten.

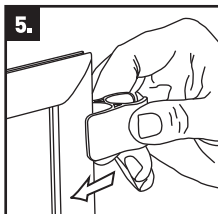

5. Snap clips onto frames first.

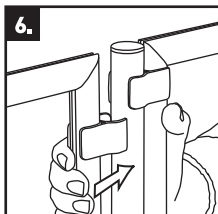

6. Then snap frames onto poles.

Note: Please layout parts in order on the floor before assembly.

