

1.5mm Cable Display Systems - INSTALLATION GUIDELINES

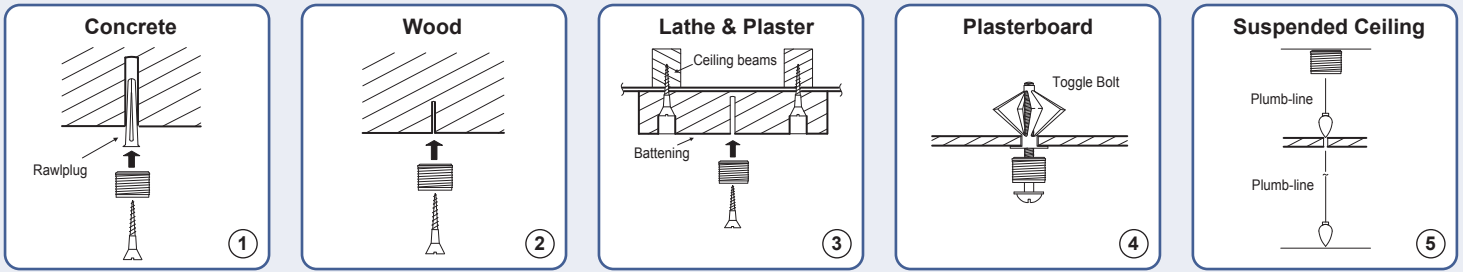

Top to Bottom (CA4) - Cable Installation

IMPORTANT: It is essential to check that the top ceiling fixings are strong enough to take the weight of the items being displayed, whilst allowing for the tension in the cables.

Isolators must be used where power is required through the cables (lighting etc) and fixings are into metal or conductive materials.

When fitting isolated cables remember to replace the top brass fitting with the plastic **PC01/I** isolator and add bottom isolator **SP/IS** to bottom fitting.

- 1) Fix fitting (A) to ceiling:
 - for wooden ceilings use a wood screw.
 - for cavity ceilings use a spring toggle bolt.
 - for solid ceilings use a rawlplug and screw.
- 2) Screw fitting (B) to fitting (A).
- 3) Using a plumb-line, plumb down from (A) and fix (F) to floor using appropriate type of fixing. For isolated cable remember to include the **SP/IS**.
- 4) Loosen the grub screws in fitting (E), using the allen key provided and slide fittings (C), (D) and (E) up the cable.
- 5) Pull down the cable and cut off in line with the decorative line around fitting (F) (see below).
- 6) Re-tighten (E) on the end of the cable.
- 7) Adjust the tension of the cable by screwing (C) into (F).

N.B. It is important to check the strength of the top fixing. No responsibility will be taken for incorrect fixing. This responsibility rests with the installer.

Cables are not supplied with fixing screws.

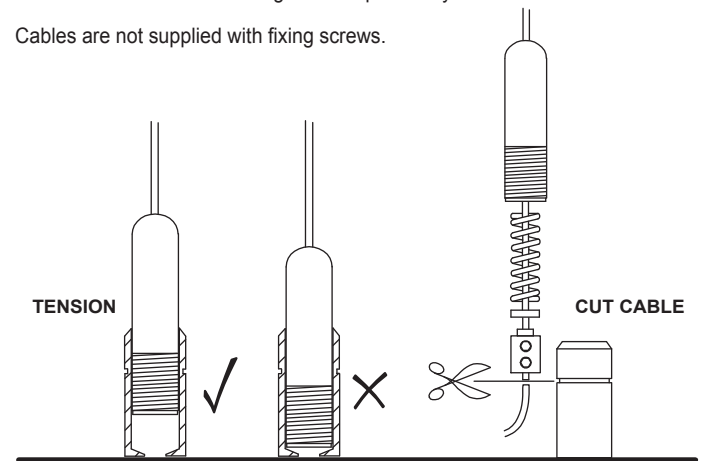
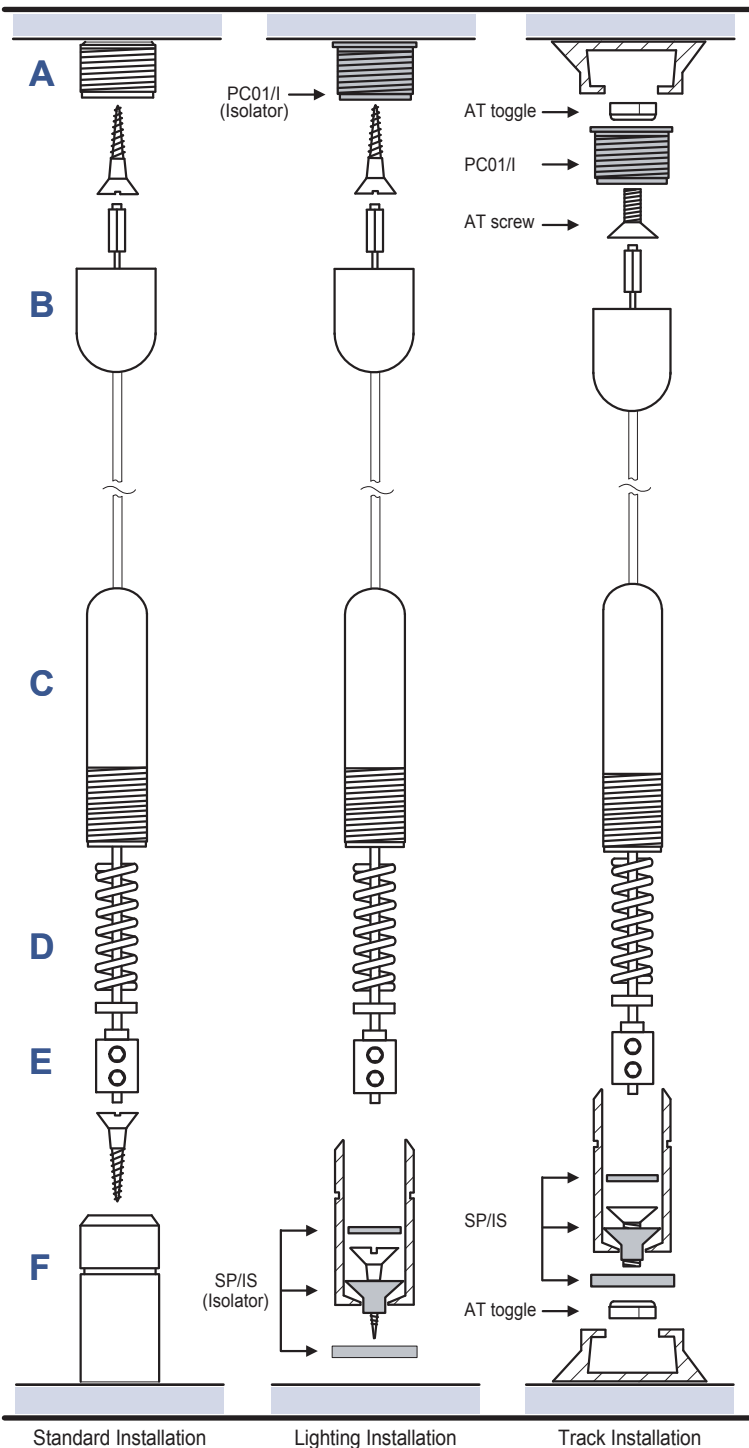

1.5mm Cable Display Systems - INSTALLATION GUIDELINES

Wall to Wall (C2WW-15/30) Cable Installation

IMPORTANT: It is essential to check that the top ceiling fixings are strong enough to take the weight of the items being displayed, whilst allowing for the tension in the cables.

- 1) Select the upper height at which cable is to start. Fix base fitting (A-A1) to wall, using a suitable fixing for the type of wall:
 - for wooden walls use a wood screw.
 - for a cavity wall use a spring toggle bolt.
 - for a solid wall use a rawlplug and screw.
- 2) Attache the wall bracket (B-B1) to the wall at a respective distance from the top fixing (A) to form a regular triangle as shown in the diagram below.
- 3) Un-tighten the set screws on the wall bracket (B1) to loose the front and back cables.
- 4) Using a plumb-line, plumb down from (A) and fix fittings (G-G1) to wall using appropriate type of fixing.
- 5) Repeat step (2 & 3) for mounting the wall bracket (F-F1).
- 6) Separate the two sections of parts (C-C1) and (E-E1) and loosen the grub screws in the small brass pieces (D-D1) using the allen key provided and slide fittings up the cable to the desire length. (Do not remove from cable).
- 7) Having selected the required length, re-tighten the brass fittings and cut off the surplus cable.
- 8) Re-connect the two sections (C-C1) and (E-E1) and tighten to adjust tension.
- 9) Re-tighten set screws on the wall bracket (B-B1) & (F-F1) to fix the front and back cables in place.

N.B. It is important to check the strength of the top fixing. No responsibility will be taken for incorrect fixing. This responsibility rests with the installer.

Cables are not supplied with fixing screws.

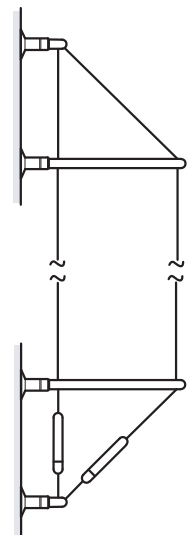
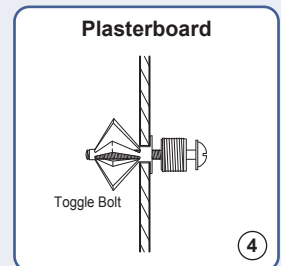
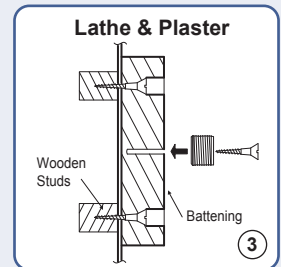
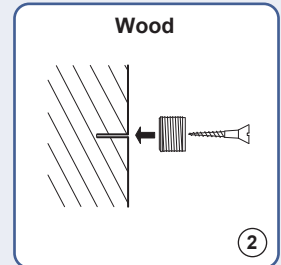
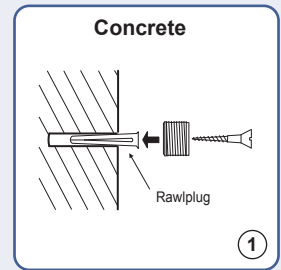
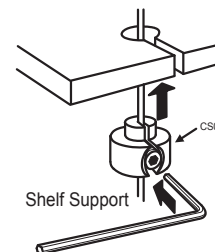
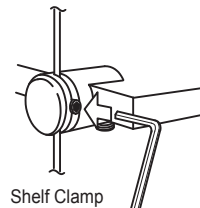
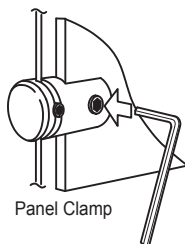
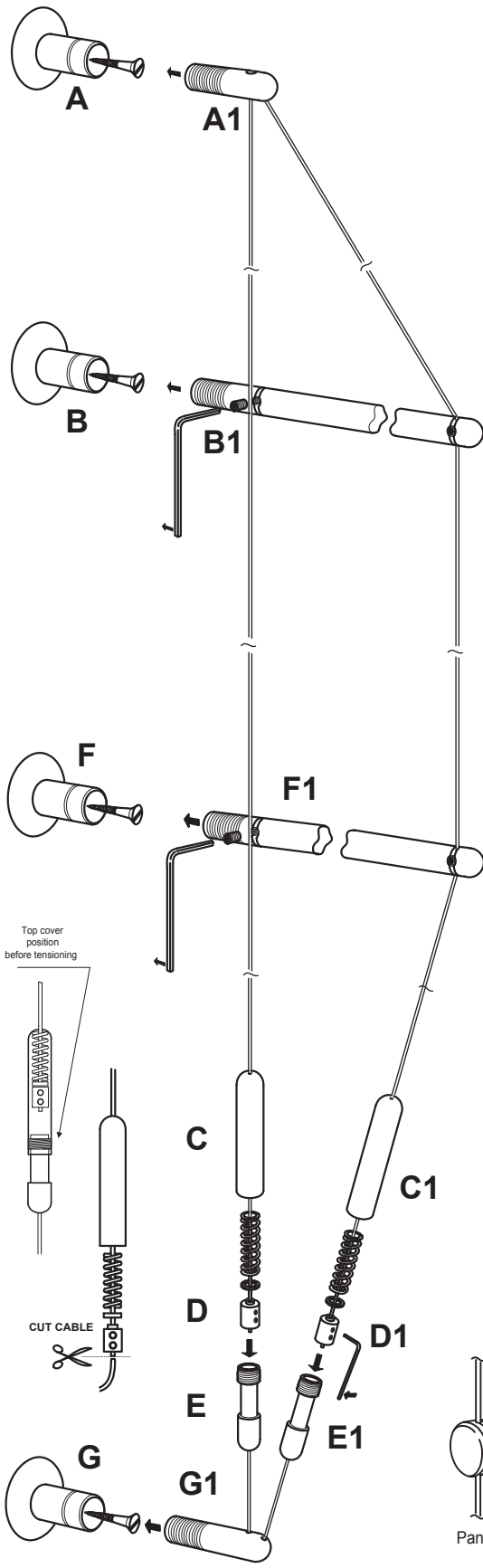

1.5mm Cable Display Systems - INSTALLATION GUIDELINES

INSTALLATION TIPS

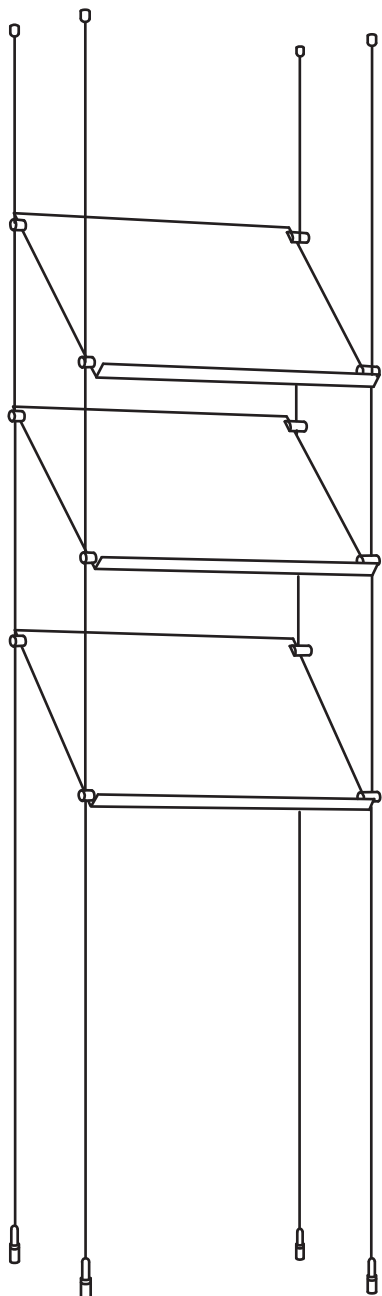

Sloping Acrylic Shelving Fixing CG11 & CG13 Support Installation

1) Attach a clamp support to each corner of the acrylic shelves at 1/2"-1" distance from edge (fig 1).

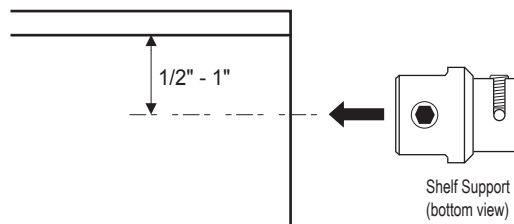

2) **Mark cable positions on floor area** - depending on the angle that you choose for shelving, mark cable positions on the floor. With the use of a plumb line mark and fix cables to ceiling (ensuring that fixings are secure).

3) Install cables as per "Cable Fixing Instructions" for CA4 supplied.

4) Shelf fitting - As a guideline the lowest shelf should be fixed approx. 24" from the floor and subsequent shelves approx 12" apart.

5) Fix shelf to cables. Adjust shelf to horizontal, preferably with a spirit level. Repeat procedure for other shelves.

Options - Double sided Clamp Supports

1) The double sided clamp support **CG21 & CG23** will need to be fitted to the cable before the second glass shelf is attached.

2) For proper and easier installation it will require two man assistance.

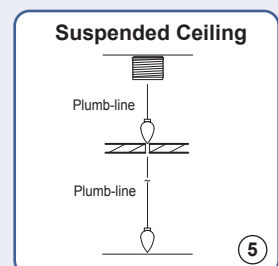
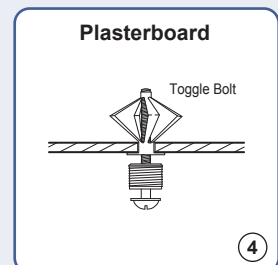
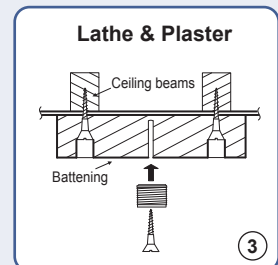
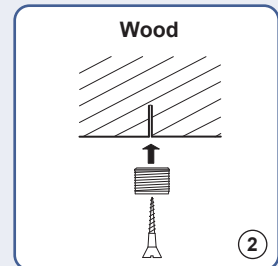
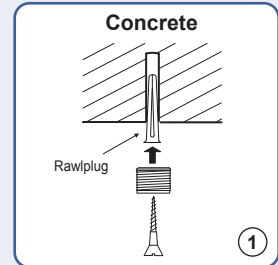
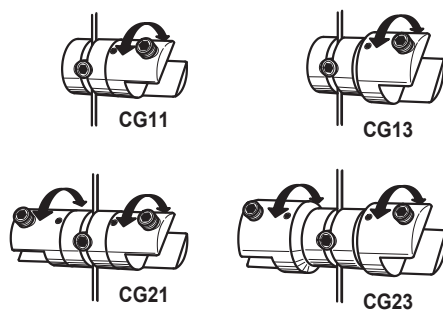
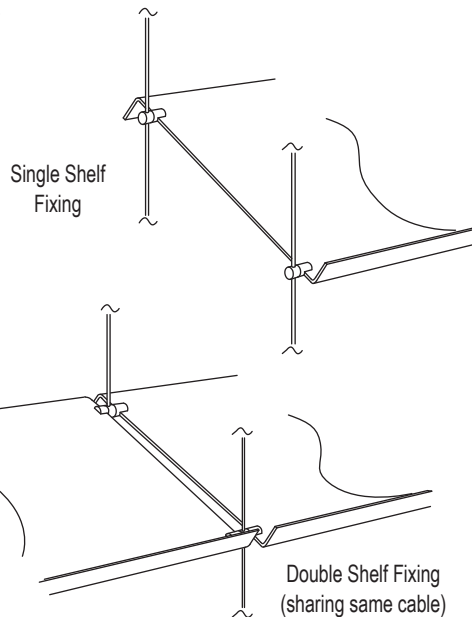

DRAWN BY	IV	TITLE	Installation Guidelines		
DATE	1/12/02	SCALE	TYPE	DRWG REF.	
		NTS	1.5mm Cable System	Instructions - PDF	